

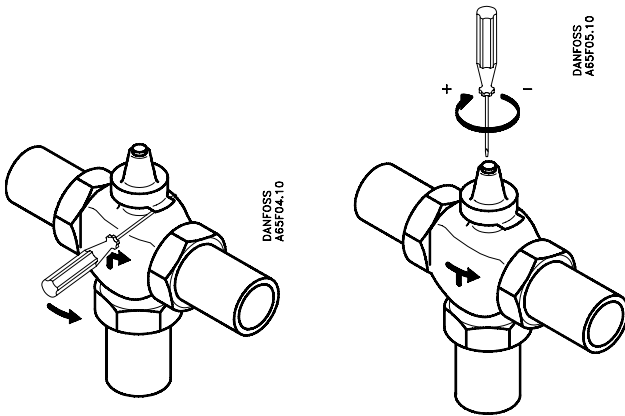

065R9179



DANFOSS
A65F04.10

DANFOSS
A65F05.10

Type	Max. Δp bar
VMV15	0,6
VMV20	0,5
VMV25	0,3
VMV32	0,2
VMV40	0,2

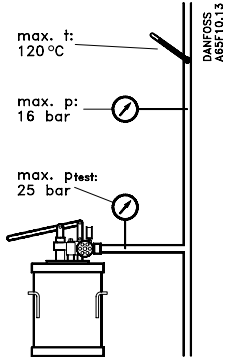

DANFOSS
A65F10.13

065R9179

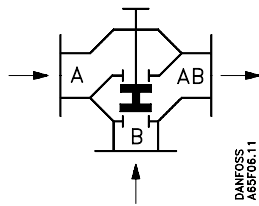

DANFOSS
A65F06.11

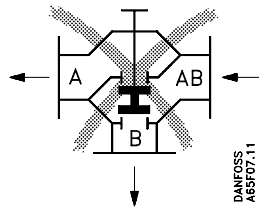

DANFOSS
A65F07.11

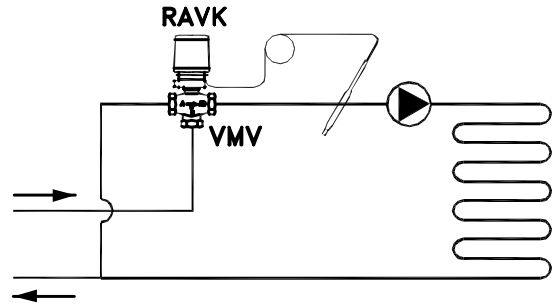

DANFOSS
A13U2014.10

NC (normally closed)
RAVK (only VMV DN 15, 20)
ABV - NC

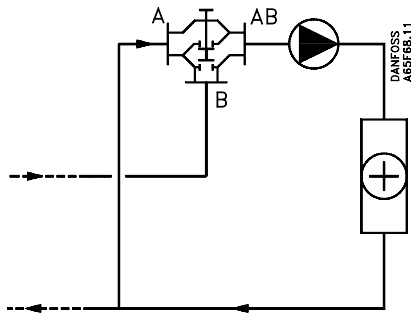

DANFOSS
A65F66.11

NC (normally closed)
RAVK (only VMV DN 15, 20)
RAVI (only VMV DN 15, 20)
ABV - NC

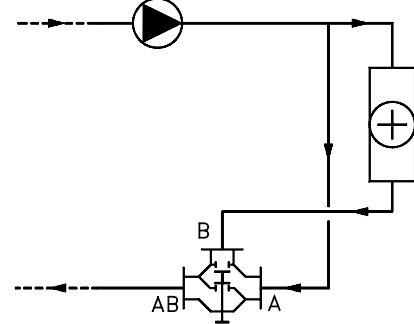

DANFOSS
A65F68.11

NO (normally open)
ABV - NO

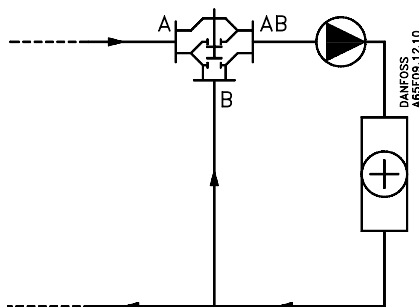

DANFOSS
A65F08.12.10

NO (normally open)
ABV - NO

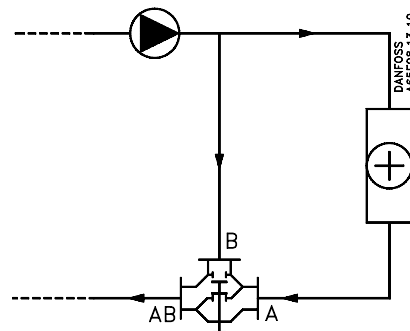

DANFOSS
A65F08.13.10